

FCR PRIMA T

Extremely fast processing in a compact body streamlines diagnosis



This compact table-top reader unit has outstandingly high-speed processing to challenge the common misconception of CR



Processing Capacity

Normal
57 IPs/hr.

With Upgrade Kit
67 IPs/hr.

• The above values are for IPs of 18 x 24 cm.
• For processing of 67 IPs/hour, the Upgrade Kit is required.

All-in-one workstation



FCR PRIMA Console / FCRView

FCR PRIMA Console and FCRView are an all-in-one viewers that turns your desktop into a multi-function workstation for all your radiographic imaging needs. You can initiate exposures, process and print your studies and backup patient information all within a single unit.

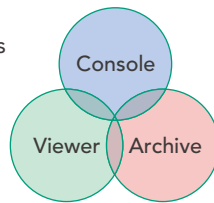

High-Speed Processing

FCR PRIMA T is a table-top reader unit which boasts a world-class high processing speed of 57 IPs/hour. With the optional Upgrade Kit this speed can be increased still further to 67 IPs/hour. As with all Fujifilm equipment FCR PRIMA T is easy to operate. It will help reduce patient waiting time and greatly increase the efficiency of examination workflow.

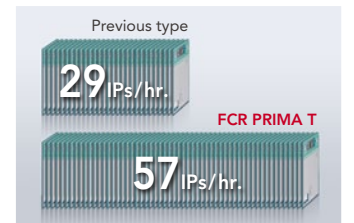

Space-Saving Design

FCR PRIMA T, with its light, compact, table top design is Fujifilm's first FCR model of this type. It can be placed on a desk or shelf or anywhere space is limited. As this is a fully digital reader neither a darkroom nor automatic processor are required. FCR PRIMA T can always be installed in the space vacated by a chemistry based processor.



Stable High-Quality Images

Although this is a compact machine its excellent image quality is the same as that produced by the rest of the FCR range. Image Intelligence™, Fujifilm's proprietary image processing technology, enhances image contrast and sharpness, without any deterioration of details. FCR PRIMA T supports accurate diagnosis by offering stable and optimized image quality.



MFP Multi-Frequency Processing

Enhances FCR images. All diagnostic scopes will be enhanced except for noise. *Optional software

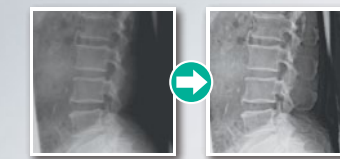

FNC Flexible Noise Control

Provides a non-grainy image by mainly isolating and suppressing the noise for the signal.

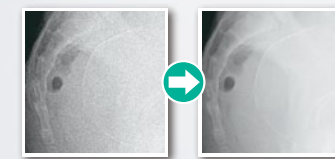

GPR Grid Pattern Removal

Removes the stationary grid patterns thus preventing Moiré from being generated resulting in easier diagnosis.

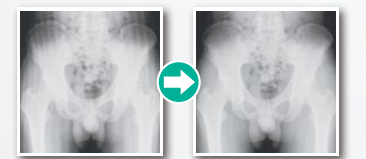

System Configuration

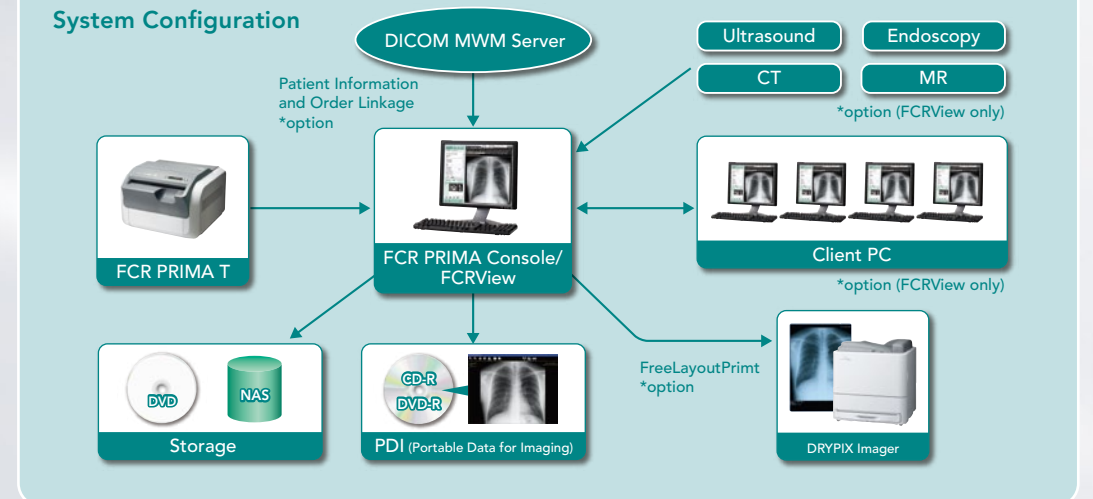

FCR PRIMA T Specifications

Standard Components	FCR PRIMA T Image Reader (Model: CR-IR 392) AC power cord
Other System Components	IP cassette type CC FCR PRIMA Console, FCRView Dry Imager: DRYPIX PRIMA, DRYPIX 2000, 4000, 7000, Plus
Supplies	Imaging Plate ST-VI: 35 × 43 cm (14" × 17"), 35 × 35 cm (14" × 14"), 10" × 12", 8" × 10", 24 × 30 cm, 18 × 24 cm, 15 × 30 cm (Variation) IP Cassette Type CC: 35 × 43 cm (14" × 17"), 35 × 35 cm (14" × 14"), 10" × 12", 8" × 10", 24 × 30 cm, 18 × 24 cm, 15 × 30 cm (Variation)
Time Required for IP Feed/Load	Min. 64 sec. (Min. 54 sec.)*
Processing Capacity	Up to 57 IPs/hr. (Up to 67 IPs/hr.)*
Reading Specification	10 pixels/mm, 5 pixels/mm**
Time to Start on Display	Min. 33 sec.
Time to Print on DRYPIX PRIMA	Approx. 165 sec. (Approx. 155 sec.)** in case of 35 × 43 cm
Number of Stacker	1
Network	10 Base T/100 Base TX
Dimensions (W × D × H)	560 × 540 × 392 mm (22" × 21" × 15")
Weight	39 kg (86 lbs.)
Power Supply Conditions	Single phase 50-60 Hz AC120-240V ±10% 1.9A (max)
Environmental Conditions	Operating Conditions: <ul style="list-style-type: none"> • Temperature: 15-30 °C • Humidity: 15-80%RH (No dew condensation) • Atmospheric pressure: 750-1060hPa

This equipment is a Class 1 laser product (IEC60825-1:2001).

* When using the Upgrade Kit

** When using the Upgrade Kit and in the High Speed mode

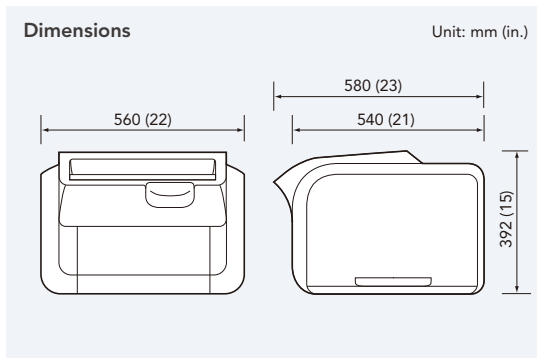

Imaging Plate ST-VI

35 × 43 cm (14" × 17"),
35 × 35 cm (14" × 14"),
10" × 12", 8" × 10",
24 × 30 cm, 18 × 24 cm,
15 × 30 cm (Variation)



IP Cassette Type CC

35 × 43 cm (14" × 17"),
35 × 35 cm (14" × 14"),
10" × 12", 8" × 10",
24 × 30 cm, 18 × 24 cm,
15 × 30 cm (Variation)

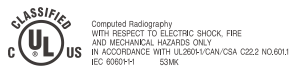

FCR PRIMA T (CR-IR 392) CE 0123

Specifications are subject to change without notice.

All brand names or trademarks are the property of their respective owners.

In some countries, regulatory approval may be required to import medical devices.

For the availability of these products, please contact your local sales representatives.

FUJIFILM

FUJIFILM Corporation

26-30, NISHIAZABU 2-CHOME, MINATO-KU, TOKYO 106-8620, JAPAN

<http://www.fujifilm.com/products/medical/>

Ref. No. XB-992E (SK-11-11-F1079-F9711) Printed in Japan ©2011 FUJIFILM Corporation